

# TRAIL CAMERA

## User Manual

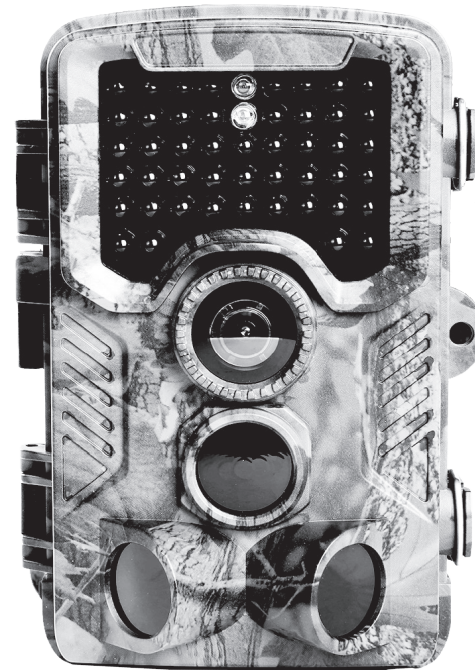

**32**  
Megapixel

**4K**  
Ultra HD

**IP66**  
Waterproof

**2.4"**  
TFT-LCD

**120°**  
120° total PIR angle

**CE FC RoHS**  
Made in China

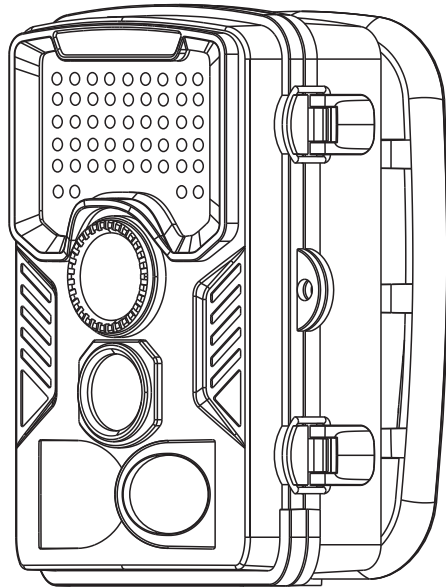

**Trail Camera**

## INTRODUCTION

With its highly sensitive 120° Passive Infrared (PIR) sensor, the camera detects the sudden change of ambient temperature caused by moving game in a region of interest (ROI), and triggers to take pictures/videos, so you don't miss what is walking in front of your camera.

### Features

- Programmable 5, 8, 12, 16, 20 or 32 Megapixel high-quality resolution.
- Infrared night vision LEDs for flash range as far as 65 feet.
- In "Photo+ Video" mode, camera takes both pictures and video at every trigger event.
- Impressively quick trigger time (0.2-0.6 second, Pre boot 0.2 second).
- Unique side Prep Sensor design provides wider sensing angle and enhances camera's response speed.
- In Time Lapse setting, the camera automatically and constantly takes pictures/videos at specified interval. This is very useful when observing plants flowering, birds building nest, or when monitoring unattended properties such as parking lots.
- With Target recording time On, the camera can be programmed to only work in specified period every day. This feature can work together with Time Lapse feature.

## INTRODUCTION

- Serial Number setting enables you to code locations in the photos. This helps multi-camera users identify the location when reviewing the photos.
- Ultra low standby power consumption. Extremely long in-field life (in standby mode, up to 8 months with 8 x AA batteries).
- Built-in 2.4" TFT color display to review images and videos.
- Date, time, temperature and moon phase can be stamped in the pictures.
- Backpack-looking tree grabber makes mounting and aiming a snap.
- Perform in the most extreme temperatures from -4°F to 140°F.
- Compact size (5.3 x 3.8 x 3.0 inches). Well designed to deploy covertly.
- Lockable and password protected.
- IP66 water resistance.

### Application

- Trail camera for hunting.
- Animal or event observation.
- Motion-triggered security camera, for home, office and community.
- All other indoor/outdoor surveillance where invasion evidence needed.

3

## CAMERA OVERVIEW

### CAMERA OVERVIEW

1. Up button
2. Right button
3. Shot button
4. Ok button
5. Left button
6. Menu button
7. Replay button
8. Down button
9. SD slot
10. USB jack
11. OFF
12. Test
13. ON
14. Infrared LEDs
15. Lens
16. Front motion sensor
17. Side motion sensor
18. Display screen

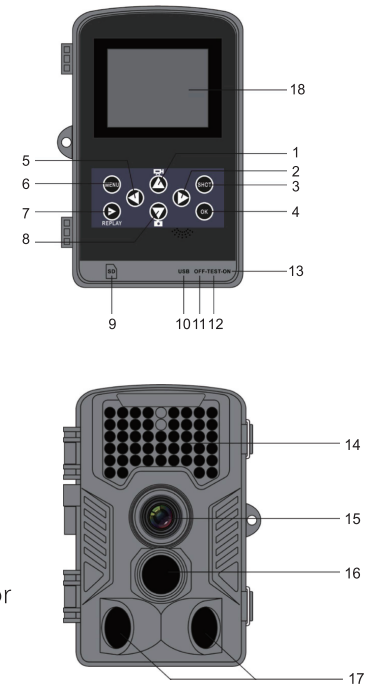

4

## SIMPLE TO USE THIS CAMERA

### SIMPLE TO USE THIS CAMERA



① Install Batteries



② Install SD Card



③ Switch to TEST



④ Press MENU to setting

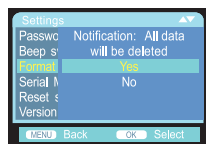

⑤ Format memory card

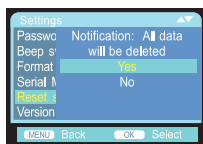

⑥ Reset to factory setting

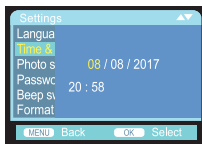

⑦ Set The Date & Time



⑧ Switch to ON to use

## BEFORE OPERATION

### Power supply

#### Batteries Installation

Open the camera by unlocking latch firstly. The battery compartment is the right part of the camera. Open the protective cover of the battery compartment and insert 4 x 1.5 V LR6/AA batteries into the battery slots. Make sure to insert each battery with correct polarity (+ and - end against the long spring of each battery slot). To increase the operating time, you can use 8 x 1.5 V LR6/AA batteries. When using 4 batteries, they all should be installed in the top 4 slots or in the bottom 4 slots.

#### Note:

- NEVER INSTALL DIFFERENT TYPES OF BATTERIES or NEW AND OLD BATTERIES in the product at the same time.
- Anytime you load or unload batteries, make sure that the camera is **OFF**. If using external power source, do not remove internal batteries.

#### Using an External Power Source

Optionally, you can connect an external 6V 1.5~2.0A DC power source to the 'DC In' jack at the bottom of the camera. The power connector is a 3.5x1.35 mm coaxial DC power plug with positive 'tip' (inside pin) polarity. Leave internal batteries in the camera during use.

## BEFORE OPERATION

### Inserting the SD Card

The camera uses a SD (Secure Digital) memory card to save photos (in .jpeg format) and/or videos (in .AVI format). SD cards up to a maximum 512 GB capacity are supported.

Insert the SD card (with the camera's power switch in the **OFF** position) before beginning to operate the camera. Don't insert or remove the SD card when the power switch is in the **ON** position.

Before inserting the memory card, please open the front cover and make sure that the write-protect switch on the side of the card is 'OFF' (NOT in the "Lock" position).

- Insert the SD card into the card slot. A "click" sound indicates that the card is installed successfully. If the wrong side of the card is facing up, you will not be able to insert it without force-there is only one correct way to insert cards.
- To take out the SD card, just gently push in the card (do not try to pull it out without pushing in first). The card is released from the slot and ready to be removed when you hear the click.

#### **Note:**

- Be sure the camera's power is switched OFF before inserting or removing SD cards or batteries.
- Camera will not operate without an SD memory card installed.

## CAMERA OPERATION

### Mode Switch

There are three basic operational modes:

- **OFF** mode: Power switch in the **OFF** position.
- **ON** mode: Power switch in the **ON** position (LCD screen is off.)
- **TEST** mode: Power switch at **TEST** position (LCD screen is on).

#### **OFF Mode**

The **OFF** mode is the "safe" mode when any actions must be taken, e.g. replacing the SD card or batteries, or transporting the device. **ON Mode**

The camera will take photos or videos automatically (according to its current parameter settings) when it is triggered by the PIR sensor's detection of activity in the area it covers. **TEST Mode**

In the **TEST** mode you can check and change the settings of the camera with the help of its built-in LCD. These settings, found in the **TEST** Menu, let you change the photo or video resolution, interval between photos, switch the time imprint on, etc.

### Mode Change Setting in TEST Mode

The main purpose of the **TEST** mode is to allow you to change the settings of the camera's parameters so your trail camera operates exactly the way you want it to.

## CAMERA OPERATION

Slide the mode switch to **TEST** position to start the test mode.

- Press the **UP** key, then press **SHOT** to take video for test.
- Press the **DOWN** key, then press **SHOT** to take photo for test.
- Pressing the **MENU** button, the setup menu will be shown on the **LCD**.
- Press the **UP** or **DOWN** key scrolls to the next or previous parameter.
- Press the **RIGHT** or **LEFT** key to change the setting.
- Press the **OK** button to save the new setting.
- Press the **MENU** button to exit the **SETUP** menu.

### Mode

Photo: Capture photos with motion detection.

Video: Capture video clips with motion detection.

Photo + Video: Capture both photos and video with motion detection.

### Photo resolution

Set resolution for still photos. We recommend the resolution of 5MP

Options: 5 MP(preset), 8 MP, 12 MP, 16 MP, 20MP, 32MP.

### Photo series

Selects how many photos are taken in sequence per trigger. In addition to single shot mode (1 photo), you can take "2 photos in series" or "3 photos in series".

## CAMERA OPERATION

### Video resolution

Select video resolution.

Options: 4K(3840 x 2160), 2.7K(2688 x 1520), 1080P (1920 x 1080), 720P (1280 x 720), WVGA (720 x 480), VGA (640 x 480)

### Video Length

Set the length of each video clip recorded each time motion is detected (between 3–60 seconds or 3–10 minutes). The longer the recording time selected the shorter the operating time. The preset video length is 10 seconds.

### Audio recording

Opening this function, you can record sound while recording video.

### Shot lag

Set the time period that the camera should wait before reacting to subsequent activation of the main sensor after the initial recording. During the selected interval, the camera will not record any images or videos. This prevents the memory card from being filled up with too many recordings of the same event. You can select between 5–60 seconds or 1–60 minutes.

### Side motion sensors

The default setting is On. The two side PIR sensors provide wider sensing angle and enhance response time. However, in some situations you have difficulty removing the interfering twigs, or avoiding the sunlight. If so, you have the option to turn

## CAMERA OPERATION

off the side sensors.

### Sensitivity motion sensors

The sensitivity of the main motion sensor is set here. For interior areas and environments with little interference, such as branches blowing in the wind, select "High". Select "Medium" for exterior areas and environments with a normal amount of interference, and select "Low" for environments with a high level of interference. The temperature can also affect the sensitivity. The "High" setting is suitable for warm ambient temperatures, whereas "Low" should be selected for cold environments.

### Target recording time

Select "On" if the camera should only be active during a certain time period. In the screen menu that subsequently appears, you can then set the start and end time for the active phase. The settings made here apply every day. The camera will not record any images outside of the active phase.

### Time lapse

Time lapse mode disables the PIR sensor and instead takes photo or records video clip automatically at



## CAMERA OPERATION

your choice of intervals. This has the advantage for scouting further distances that out of the PIR sensor's range, such as big open areas (food plots, fields, etc) or monitoring the flowering, sunrise and sunset. When you confirm "On" with the OK button, you can then set the desired time interval using the menu that now appears.

### Language

Here you can set English, German, Finnish, Swedish, Danish, French, Italian, Dutch, Spanish or Portuguese as the menu language.

### Time & date

Here you can set the date format (YYYY/MM/DD, DD/MM/YYYY or MM/DD/YYYY), the time format (12/24 hrs) and the time and date. Use **LEFT** and **RIGHT** keys to move to next field. Use **UP** or **DOWN** keys to change the setting, pressing **OK** button to save.

### Photo stamp

Select **ON** to print the temperature, moon phase, date, and time on each photo (only for photos). Select OFF for no imprint.

### Password protection

Select "On" if you want to use a password to protect the camera from unwanted access. You can set a 4-digit combination. Once the code is set, the camera will prompt you to enter the correct code.

### Format memory card

Deletes (erases) all files stored on a card to prepare it for reuse. Always format a card that has been previously used in other devices



## CAMERA OPERATION

**Caution! Make sure you have downloaded and backed up any files you want to preserve first!** Press OK to execute, press MENU to exit without formatting.

### Serial NO

Select "On" if you want to use a serial number to rank the camera. You can set a 4-digit combination. This helps multi-camera users identify the location when reviewing the photos, since each camera will imprint its number on all photos it captures.

### Reset setting

Select 'Yes' and press OK to restore all parameters to the original factory default settings.

### Aligning the camera

In test mode you can work out the optimum exposure angle and the range of the motion sensors.

► During alignment, consider whether the use of the side motion sensors may be useful for attaining the desired observation results. You can activate/deactivate the side motion sensors using the above-described menu.

### Align the camera as follows:

Fasten the camera to a tree or similar object at a height of 0.8–1.3 meters to avoid aligning too much higher than the height of shooting subjects and align the camera in the desired direction. Then move slowly from

## CAMERA OPERATION

one side of the target area to the other side. While doing this, monitor the motion display.

If this lights up in blue, you have been detected by one of the activated side motion sensors. If it lights up in red, you have been detected by the front motion sensor. In this way, you can work out the best alignment for the camera.

The motion display only lights up when the operating mode selector switch is in the SET position and one of the motion sensors has detected movement. During normal operation, there will be no LED display in this case.

To ensure that the camera does not make unwanted recordings of irrelevant movements, it should not be set up in a sunny location or close to branches that can move in the wind. The recording angle of the sensors is about 110° from corner to corner; and the recording field for photos and videos is around 110°.



## CAMERA IS READY TO USE

### CAMERA IS READY TO USE---Switch to ON

AFTER CHANGING TO DESIRED SETTING and SIMPLY SLIDING SWITCHES TO ON POSITION, the camera is active standby mode and will record media according to the switch settings. Firstly, the motion indicator LED will blink red for about 5 seconds. Any motion is detected by the side PIR sensor; the camera will be active without trigger. As soon as the further motion is detected by the central PIR sensor within 5 minutes, the camera will take photos or videos. Otherwise, the unit will return to standby state.

## VIEWING/DELETING THE PHOTOS/VIDEOS

### VIEWING/DELETING THE PHOTOS/VIDEOS

#### Reviewing Images on the Camera LCD

- Put the power switch in **TEST** position.
- Press the **Replay** key to enter image review mode.
- Use the **UP/DOWN** keys to scroll through your photos or videos.  
A zoom feature is available for still photos: Use the **OK/SHOT** keys to zoom in or out. Press the **UP/DOWN** keys at anytime to exit.
- Press the **OK** keys to play or pause a video.

#### Deleting Photos or Videos

- Put the power switch in **TEST** position.
- Press the **Replay** key to enter image review mode.
- Press the **MENU** key. You will see the first **Delete** screen.
- It lets you select the option to delete only the currently displayed photo/video, or all photos/videos.
- Press **OK** to Delete.
- Press **MENU** to cancel the operation without deleting any files.

#### Activate slide show

This function can be used to play back the photos stored on the memory card automatically. Each photo is shown for about 2 seconds. To stop the slide show and keep the current image permanently on the screen, press the **OK** button.

## VIEWING/DELETING THE PHOTOS/VIDEOS

### Write protection

This function can be used to protect individual recordings or all saved recordings from accidental deletion.

- ◆ Select “Write-protect current file” to protect the currently selected recording from accidental deletion.
- ◆ Select “Write-protect all files” to protect all saved recordings from accidental deletion.
- ◆ Select “Unlock current file” to remove the write protection for the currently selected recording.
- ◆ Select “Unlock all files” to remove the write protection for all saved recordings.

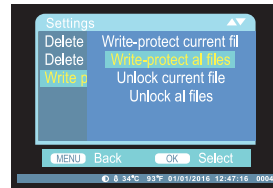

### Reviewing Images Directly from the SD Card

This is the most popular method of viewing images. Removing the SD card and take it to your home or campsite to view the images by using an SD card “reader” connected to your computer (some computers and TVs have a built in SD card slot).

### Reviewing Images by Connecting to a Computer

When using a PC or Mac to view photos or video clips, first connect the device to the computer with the supplied USB cable.

## VIEWING/DELETING THE PHOTOS/VIDEOS

It will be recognized as a ‘mass storage’. You can view images and videos in the folder \DCIM\.

### Showing recordings on an external monitor

A TV monitor can also be used to play back pictures (or videos) from the device. Connect a TV to the camera using the supplied cable. Then:

- Set the video input source of the TV to ‘video’.
- Put the power switch in TEST mode.
- Use REPLAY/UP/DOWN/OK/SHOT keys to view photos/videos.

## TROUBLE SHOOTING/FAQ

### TROUBLESHOOTING / FAQ

#### Photos Do Not Capture Subject of Interest

These are the result of placing the camera in an environment where there is motion associated with tree branches creating motion or an area where there is high heat in the foreground and any motion from wind. Setting a camera up over water is also a potential cause for this issue. To remedy this situation:

1. Try moving the camera to an area that does not have any of these issues.
2. If the camera continues to take images of no interest subject, try placing the camera in an inside environment and aiming at a location where there is no motion.
3. If the camera continues to show issues, please contact our customer service.

#### Battery life is shorter than expected

1. Battery life will vary with operating temperature and the number of images taken over time. Typically, the camera will be able to capture several thousand images before the batteries die.
2. Check to make sure you have used new alkaline batteries.
3. Make sure that the power switch was turned to the **ON** position and not in the **TEST** modes.

## TROUBLE SHOOTING/FAQ

### Camera won't take images

1. Please make sure that the SD card is not full. If the card is full, the camera will stop taking images.
2. Check the batteries to make sure that they are new alkaline.
3. Make sure that the camera power switch is in the **ON** position and not in the **OFF** or **TEST** modes.
4. If the SD card has its write protect switch in the lock position, the camera will not take images.
5. If you have used an SD card in another device before, you might want to try formatting the card.

### Camera won't power up

1. Make sure that you have installed at least a full set of 4 batteries in correct position.
2. Make sure that the batteries are installed correctly, observing proper polarity.
3. After moving the switch from **OFF** to **TEST** or **ON**, make sure that the switch is correctly in position to ensure the proper mode.
4. Do not move the switch directly from **ON** to **TEST**, always move the switch all the way down to **OFF** first, then back up to **TEST**.

### Still Photo and/or Video Quality Problems

1. Night photos or videos appear too dark
  - a. Check the battery indicator icon to see if battery power is full. The flash will stop operating near the end of the battery life.

## TROUBLE SHOOTING/FAQ

- b. You will get the best results when the subject is within the ideal flash range, no farther than 65 feet.
- c. Please note that when the Capture Number parameter is set higher than "1 Photo", or with very short Interval settings, some images may appear darker than others due to the quick response and rapid re-triggering of the camera, allowing less time for the flash to fully recharge before firing again.
- 2. Daytime photos or videos appear too dark  
Make sure that the camera is not aimed at the sun or other light sources during the day.
- 3. Night photos or videos appear too bright  
Subjects may appear too bright at closer distances.
- 4. Daytime photos or videos appear too bright  
Make sure that the camera is not aimed at the sun or other light sources during the day.
- 5. Photos with streaked subject
  - a. In some cases with low lighting conditions and fast moving subjects, the 8MP or 12MP resolution settings may not perform as well as the 5MP setting.
  - b. If you have multiple images where fast moving subjects produce streaks on the photo, try the 5MP setting instead.
- 6. Short video clips—not recording to the length set
  - a. Check to make sure that the SD card is not full.
  - b. Make sure that the camera has good batteries in it. Near the end of the battery life, the camera may choose

## TROUBLE SHOOTING/FAQ

to record shorter video clips to conserve power.  
**Date/Time Stamp not appearing on images**  
Make sure that the Time Stamp parameter is set to 'On'.

### **PIR Sensor LED Flashes/Doesn't Flash**

1. When the camera is in the **TEST** mode, a special **LED** on the front of the camera will flash when it senses motion. This is for setup purposes only and will help the user aim the camera.
2. During use, the **LED** will not flash when the camera takes an image. This is to help keep the camera hidden from game.

### **Camera won't retain settings**

Make sure that you have been saving the changes to any parameter settings that you made while in Setup mode, by pressing OK after changing the setting.

### Moisture or Ants inside Camera

1. To ensure humidity or rain is kept out of the camera, secure the DC In plug firmly in place.
2. Ants can be attracted by low level electronic vibrations, and enter through any gaps between the exterior and interior of the camera. Make sure the DC In plug is securely attached.

## CAMERA SPECIFICATIONS

### CAMERA SPECIFICATIONS

|                            |  |
|----------------------------|--|
| Photo resolution           | 32MP; 20MP; 16MP; 12MP; 8M; 5M                             |
| Video resolution           | 4K; 2.7K; 1080P; 720P; VGA                                 |
| File format                | JPEG/AVI   |
| Lens                       | f=4; F/NO=2.0; FOV=110°; Auto IR filter                    |
| Display                    | 2.4" TFTLCD  |
| External memory            | SD card up to 512GB  |
| Internal memory            | Stack 256Mb DDR  |
| Range of IR flash          | 65 Feet  |
| Triggering distance        | 65 Feet (Below 77°F/25°C at the Normal Level)              |
| Detection angle of sensors | 120°   |
| PIR Sensitivity            | High/Normal/Low  |
| Temperature compensation   | Yes  |
| Prep PIR Sensing Angle     | On/Off; 120°   |
| Triggering time            | 0.6 Second(When using the 4G SD card); Pre boot 0.2 Second |
| Shot lag                   | 5 seconds to 60mins programmable                           |
| Photo series               | 1-3, programmable  |

## CAMERA SPECIFICATIONS

|                         |  |
|-------------------------|--|
| Effectiveness           | Daytime:1m-infinite;Night time:1m-20m                    |
| Video Length            | 3-60sec;Programmable                                     |
| Photo+Video             | First take Picture then Video                            |
| Time Stamp              | On/Off; Include serial No., temperature and moon phase   |
| Time Lapse              | On/Off; Time Lapse Programmable                          |
| Target recording time   | 00:00 to 23:59 programmable                              |
| Password                | 4-Digit Numbers  |
| Build-in Microphone     | Yes  |
| Build in Speaker        | Yes  |
| Auto-distinguish images | Color images in daytime/black & white night images       |
| Auto Power Off          | Auto power off in 2 minutes while no keypad controlling  |
| TV-out                  | Yes  |
| PC Interface            | Mini USB2.0  |
| Power supply            | 4xAA;Expandable to 8xAA external 6V1.5~2.0A power supply |
| Standby time            | approx 8 months  |
| Spray-water protected   | Yes (IP protection class66)                              |
| Operating Temperature   | -20°C to +60°C   |
| Dimensions              | 5.3 x 3.8 x 3.0 inches                                   |

## CUSTOMER SERVICE & WARRANTY

### WARRANTY

#### Up to 2 YEAR LIMITED WARRANTY

**Your product is warranted to be free of defects in materials and workmanship for 2 year after the date of purchase. This warranty does not cover damages caused by misuse, improper handling, and installation.**

### FCC STATEMENT

This equipment has been tested and found to comply with the limits for a Class B digital device, pursuant to part 15 of the FCC Rules. These limits are designed to provide reasonable protection against harmful interference in a residential installation. This equipment generates uses and can radiate radio frequency energy and, if not installed and used in accordance with the instructions, may cause harmful interference to radio communications. However, there is no guarantee that interference will not occur in a particular installation. If this equipment does cause harmful interference to radio or television reception, which can be determined by turning the equipment off and on, the user is encouraged to try to correct the interference by one or more of the following measures:

Reorient or relocate the receiving antenna.

## CUSTOMER SERVICE & WARRANTY

Increase the separation between the equipment and receiver.

Connect the equipment into an outlet on a circuit different from that to which the receiver is connected.

Consult the dealer or an experienced radio/TV technician for help



## ELECTRICAL SAFETY INSTRUCTIONS

To prevent personal injury or property damage, read and follow all electrical safety instructions before using the product.

### Safety of the batteries

Keep all batteries out of the reach of children

· For rechargeable batteries

1. Rechargeable batteries should only be charged under the supervision of adults
2. Do not overcharge the battery. When charging, pay attention to the instructions for charging the batteries in the user manual.
3. Remove the rechargeable batteries from the product before charging. With built-in batteries, turn off the device before charging.
4. The rechargeable battery (with battery cable) and the USB charging cable should be checked regularly for damage to cables, connectors, housings and other parts. If damage or extreme wear is detected, do not use the rechargeable battery or the USB charging cable. Contact our customer service for a replacement device for free.
5. Remove the rechargeable batteries from the device during extended periods of non-use. For built-in rechargeable batteries, store them in a cool, dry, well-ventilated place.

## ELECTRICAL SAFETY INSTRUCTIONS

· For non-rechargeable batteries

1. Make sure the + and – poles are properly plugged in when you insert the batteries
2. Do not short the positive (+) and negative (–) poles
3. Do not charge disposable batteries
4. Do not mix the old ones with new batteries or different types of batteries
5. Dispose of all batteries safely. Never burn the batteries as they could explode.
6. Always remove dead batteries from the product.
7. Always remove the batteries from the product when not in use for a long time.